

IL-022 - LOMBARDINI - LDW 2204

1.500 R.P.M. | 50 Hz

TECHNICAL SPECIFICATIONS



Model:

IL-022

Gen set with manual control panel.

Image for guidance purposes.

ENGINE	MAKE	MODEL
	LOMBARDINI	LDW 2204

ALTERNATOR	MODEL
	MECC-ALTE ECP 28-M/4

(400 / 230 V)

CONTINUOUS POWER:
(PRP "Prime Power" norma ISO 8528-1) **20 kVA**

STAND-BY POWER:
(LTP "Limited Time Power" norma ISO 8528-1) **22 kVA**

Amperes in the different voltages:

VOLTAGE	HZ	PHASE	COS Ø	PRP KVA/KW	LTP KVA/KW	AMPERAGE
415/240	50	3	0,8	19,4/15,5	21,4/17,1	29,74
400/230	50	3	0,8	19,4/15,5	21,4/17,1	30,86
380/220	50	3	0,8	19,4/15,5	21,4/17,1	32,48
240/139	50	3	0,8	19,4/15,5	21,4/17,1	51,43
230/133	50	3	0,8	19,4/15,5	21,4/17,1	53,66
220/127	50	3	0,8	19,4/15,5	21,4/17,1	56,1

ELECTRO EXIM SRL

ELECTRO EXIM SRL
21 Ialomicioarei St., sector 1, code 011277, BUCHAREST - ROMANIA
Phone: 0040 21 2231347 - 0040 744 755 390 - FAX: 0040 21 2231201
E-mail: office@electroexim.com - Web: www.electroexim.ro

IL-022 - LOMBARDINI - LDW 2204

1.500 R.P.M. | 50 Hz

ENGINE CHARACTERISTICS

MAKE	MODEL
LOMBARDINI	LDW 2204

GENERAL DATA

Power PRP (kWm)	17.70
Power LTP (kWm)	19.50
No. cylinders	4
Cylinder capacity (L)	-
Diameter per stroke (mm)	88 x 90,4
Compression ratio	22.10
Cooling system	LIQUID
Injection	INDIRECT
Suction	NATURAL
Series regulator	MECHANICAL
Fly wheel coupling	4 - 7,5"

Lubrication system

Oil capacity (L)	5.70
Oil consumption (%)	0.03
Min. alarm oil pressure (bar)	1.50

Ventilation system

Air cooling flow (m3/h)	3199
Combustion air flow (m3/h)	82.40
Max. back pressure for fan (mbar)	0

Exhaust system

Exhaust gas flow (m3/h)	-
Exhaust back pressure (mbar)	-
Temp. exhaust gases (°C)	-

Electrical system

VDC (V)	12
Battery (Ah)	60
Engine start-up (kW)	-

ELECTRO EXIM SRL

ELECTRO EXIM SRL
 21 Ialomicioarei St., sector 1, code 011277, BUCHAREST - ROMANIA
 Phone: 0040 21 2231347 - 0040 744 755 390 - FAX: 0040 21 2231201
 E-mail: office@electroexim.com - Web: www.electroexim.ro

IL-022 - LOMBARDINI - LDW 2204

1.500 R.P.M. | 50 Hz

ALTERNATOR CHARACTERISTICS

MODEL

MECC-ALTE ECP 28-M/4 (400 / 230 V)

GENERAL DATA

Power PRP (kVA)	20.00
Power LTP (kVA)	22.00
Efficiency Alt. 3/4 %	88.00
Efficiency Alt. 4/4 %	87.60
No. Poles	4
Voltage regulator	DSR
No. wires	12
Insulation	H
Xd (%)	175.00
X'd (%)	16.50
X	9.40
Degree of protection	IP23

GENERATOR SET CONSUMPTION

% POWER USED	LITRES/HOUR
50%	2.74
75%	4.06
100%	5.40

DIMENSIONS, CAPACITIES, APPROXIMATE WEIGHT AND NOISE

LENGTH	DIMENSIONS (MM)	
	WIDTH	HEIGHT
2000	950	1253

FUEL TANK (LITRES)	WEIGHT (KG)
85.00	785.00

NOISE LEVEL (dB (A))
62 dB (A) @ 7 m

IL-022 - LOMBARDINI - LDW 2204

1.500 R.P.M. | 50 Hz

INMESOL GENERATOR SET

GENERAL DESCRIPTION

The "INMESOL" generator set is an electrical energy generating machine which is used in places where there **is no mains supply** or when there is a MAINS failure.

The mobile elements, distribution belt, fan, etc., and those parts which reach high temperatures during operation, exhaust manifold, etc, include their corresponding protections, in compliance with the requirements of the Machinery Directive **2006/42**.

REGULATIONS



The machine holds the "CE" marking, and the corresponding Declaration of Conformity is issued with each of them, in which it specifies that the machine complies with **R.D 842/2002 Low Voltage Regulations and with the European Directives:**

- 2006/42 on Safety in Machinery.
- 2006/95/CE on Electrical Safety.
- 2004/108/CE on Electromagnetic Compatibility.
- 2005/88/CE on NOISE EMISSIONS by equipment for outdoor use (for SOUNDPROOF GENERATOR SETS).

IL-022 - LOMBARDINI - LDW 2204

1.500 R.P.M. | 50 Hz

IN INDUSTRIAL RANGE / SCOPE OF SUPPLY

		
Engine/alternator monobloc directly connected and installed via silent blocks on a frame made from high tensile electro welded steel profiles that are treated with degreasing liquids and aplicated with a phosphate coat and epoxi paint.	<input checked="" type="checkbox"/>	<input checked="" type="checkbox"/>
Canopy of steel sheet sound proofed with fireproof rockwool, and treated with degreasing liquids and aplicated with a phosphate coat and epoxi paint.	<input type="checkbox"/>	<input checked="" type="checkbox"/>
Fuel tank integrated in the base frame provided with fuel level jauge and fuel connections to the engine.	<input checked="" type="checkbox"/>	<input checked="" type="checkbox"/>
Engine with mechanical engine driven pusher fan.	<input checked="" type="checkbox"/>	<input checked="" type="checkbox"/>
Industrial silencer with -15 db(A) noise reduction and exhaust outlet tube.	<input checked="" type="checkbox"/>	<input type="checkbox"/>
Residencial silencer with -35 db(A) noise reduction with exhaust tube and protection cap.	<input type="checkbox"/>	<input checked="" type="checkbox"/>
Electric control cubicle with control module including protection and reading of electrical meassures engine instrumentation fuel level and engine running hours, etc.	<input checked="" type="checkbox"/>	<input checked="" type="checkbox"/>
Termal and magnetic circuit breaker and termal and magnetic circuit breaker and earth fault relay.	<input checked="" type="checkbox"/>	<input checked="" type="checkbox"/>
Battery charge alternator.	<input checked="" type="checkbox"/>	<input checked="" type="checkbox"/>
Starter battery complete with cables to the engine and pole protection.	<input checked="" type="checkbox"/>	<input checked="" type="checkbox"/>
Installation prepared for earthing spike (spike not included).	<input checked="" type="checkbox"/>	<input checked="" type="checkbox"/>
Security protection for heat and moving parts as well as live electrical components.	<input checked="" type="checkbox"/>	<input checked="" type="checkbox"/>
External emergency stop push button.	<input checked="" type="checkbox"/>	<input checked="" type="checkbox"/>
Manual engine oil extraction pump.	<input type="checkbox"/>	<input checked="" type="checkbox"/>
Self excited and auto regulated alternator.	<input checked="" type="checkbox"/>	<input checked="" type="checkbox"/>
Integrated lifting hook for single point lifting with crane, gensets up to 450 kVA (Except in swing-out cover model)	<input type="checkbox"/>	<input checked="" type="checkbox"/>
4 Lifting points for gen sets from 450 kVA and bigger.	<input checked="" type="checkbox"/>	<input type="checkbox"/>
Preparate for extended fuel tank, fully bomded for leakage protection.	<input checked="" type="checkbox"/>	<input checked="" type="checkbox"/>
Base frame is prepared for trailer kit installation.	<input checked="" type="checkbox"/>	<input checked="" type="checkbox"/>
Standard electronic speed governor on engines from 220 kVA (LTP) and up.	<input checked="" type="checkbox"/>	<input checked="" type="checkbox"/>
Horizontal outlet for hot air	<input type="checkbox"/>	<input checked="" type="checkbox"/>

DSE 3110 MANUAL CONTROL PANEL

DSE 3110 MANUAL CONTROL PANEL

MANUAL CONTROL, PROTECTION AND DISTRIBUTION panel, assembled on the generator set in metal cabinet with a DSE 3110 engine protection unit.



It has the following:

Image for guidance purposes.

1 STARTER SWITCH

2 EMERGENCY STOP PUSHBUTTON

3 MEASURING INSTRUMENTS:

- 3 Analogue Ammeters.
- 1 Analogue Voltmeter with a separated phases selector.
- Fuel Level Indicator
- Digital Reading of Hz and Functioning Hours Counting (DSE 3110)

DSE 3110 MANUAL CONTROL PANEL

4 SET CONTROL AND ENGINE PROTECTION: DSE 3110, allows:

- START AND STOP the set MANUALLY.
- Possibility of doing it AUTOMATICALLY via START ON SIGNAL
- Digital readings of the operating hours and the Frequency
- Controls the main characteristics of the engine, causing an alarm or stopping the machine:
 - 1.Low and High Voltage (STOP)
 - 2.Low and High Frequency and Speed (STOP)
 - 3.Low Oil Pressure and High Coolant Temperature (STOP)
 - 4.Failure of the Alternator Battery-Charger (ALARM)
 - 5.Low fuel level (ALARM)

5 PROTECTIONS:

- Magnetothermal Protections
- Earth Leak Protection
- Protection fuses for control module

IL-022 - LOMBARDINI - LDW 2204

1.500 R.P.M. | 50 Hz

DSE 3110 MANUAL CONTROL PANEL

For **OPEN sets** - Three-phase generators (single phase by request):

CONT . POW.	MAGNETO. PROTECTION (A)	EARTH LEAK PROTECTION	DISTRIBUTION
10 kVA	4P, 16A (B)	Mod. 16A, 300 mA	1 B. CEE 3P+N+T 16A
13 kVA	4P, 20A (B)	Mod. 25 A, 300 mA	1 B. CEE 3P+N+T 32A
15 kVA	4P, 25A (B)	Mod. 25 A, 300 mA	1 B. CEE 3P+N+T 32A
20 kVA	4P, 32 A (B)	Mod. 32 A, 300 mA	1 B. CEE 3P+N+T 32 A
	1P+N 16 A (C)		1 B. CEE 2P+T 16 A
30 kVA	4P, 50 A (B)	Mod. 63 A, 300 mA	1 B. CEE 3P+N+T 63 A
	3P 16 A (C)		1 B. CEE 3P+N+T 16 A
40 kVA	1P+N 16 A (C)	Mod. 63 A, 300 mA	1 B. CEE 2P+T 16 A
	4P, 63 A (B)		1 B. CEE 3P+N+T 63 A
50 kVA	3P 16 A (C)	Electronic adjustable	1 B. CEE 3P+N+T 16 A
	1P+N 16 A (C)		1 B. CEE 2P+T 16 A
60 kVA	4P, 100 A (B)	Electronic adjustable	1 B. CEE 3P+N+T 125 A
	3P 16 A (C)		1 B. CEE 3P+N+T 16 A
75-80 kVA	1P+N 16 A (C)	Electronic adjustable	1 B. CEE 2P+T 16 A
	4P, 125 A (B)		1 B.CEE 3P+N+T 16 A
100 kVA	3P 16 A (C)	Electronic adjustable	1 B.SCHUKO 2P+T 16 A
	1P+N 16 A (C)		1 POWER TERMINALS
125-150 kVA	3P, 160 A (B)	Electronic adjustable	1 B. CEE 3P+N+T 16A
	3P 16 A (C)		1 B. SCHUKO 2P+T 16 A
200-275 kVA	1P+N 16 A (C)	Electronic adjustable	1 B. CEE 3P+N+T 16A
	3P, 250 A (B)		1 B. SCHUKO 2P+T 16 A
300-400 kVA	3P 16 A (C)	Electronic adjustable	1 B. CEE 3P+N+T 16A
	1P+N 16 A (C)		1 POWER TERMINALS
450 kVA VOLVO	3P, 400 A (B)	Electronic adjustable	1 B. CEE 3P+N+T 16A
	3P 16 A (C)		1 B. SCHUKO 2P+T 16 A
430 kVA DEUTZ	3P, 630 A (B)	Electronic adjustable	1 B. CEE 3P+N+T 16A
	1P+N 16 A (C)		1 POWER TERMINALS
450-500 kVA	3P, 800 A (B)	Electronic adjustable	1 B. CEE 3P+N+T 16A
570-650 kVA	3P 16 A (C)	Electronic adjustable	1 B. SCHUKO 2P+T 16 A
	1P+N 16 A (C)	Electronic adjustable	1 POWER TERMINALS
	3P, 800 A (B)	Electronic adjustable	1 POWER TERMINALS
	3P, 630 A (B)	Electronic adjustable	1 POWER TERMINALS
	3P, 1000 A (B)	Electronic adjustable	1 POWER TERMINALS

IL-022 - LOMBARDINI - LDW 2204

1.500 R.P.M. | 50 Hz

DSE 3110 MANUAL CONTROL PANEL

6 OPTIONAL:

AUTOMATIC PANEL FOR MANUAL GENERATOR: ATS DSE 334

- This panel provides the manual control generator with a reserve operation from the Mains, as the ATS sends the command to start and stop the generator, when it detects a supply failure and when the Mains is restored



Cubicle composed of the electronic control module which is detecting a mains failure and of 2 contactors mechanically and electrically interlocked or a motorized switch controlled by the above electronic controller who are realizing the change of supply from the GEN SET or the MAINS to the load.

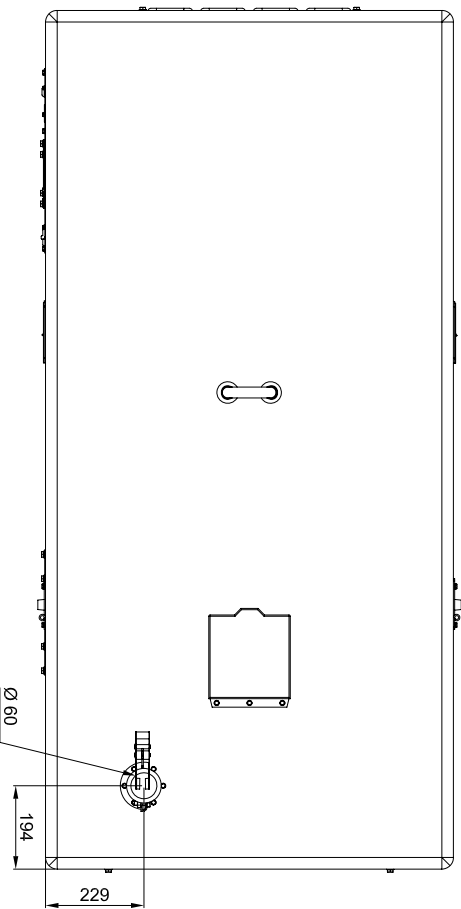
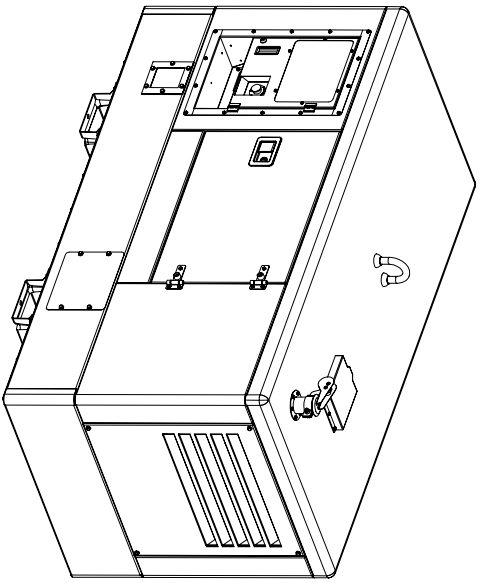
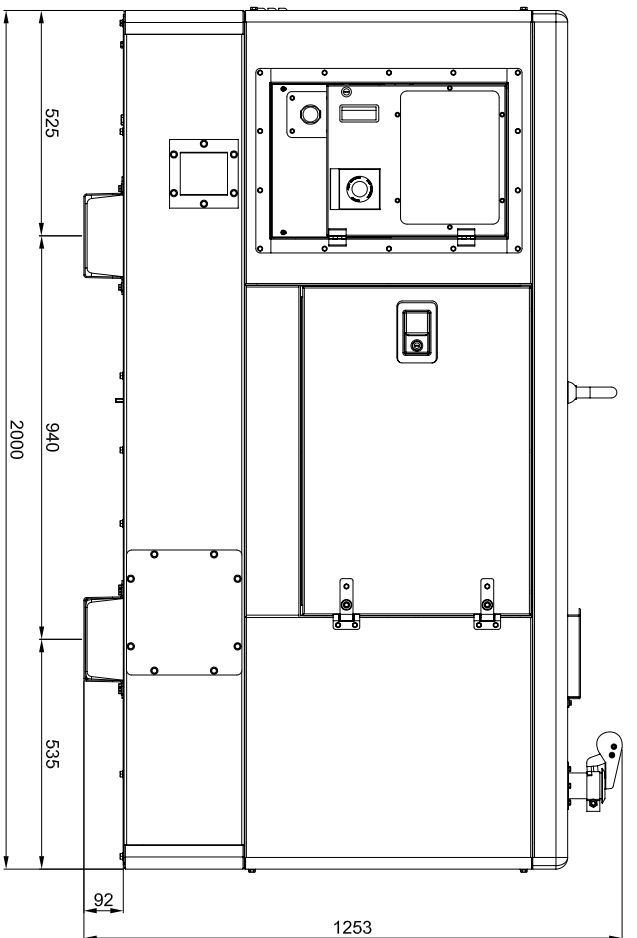
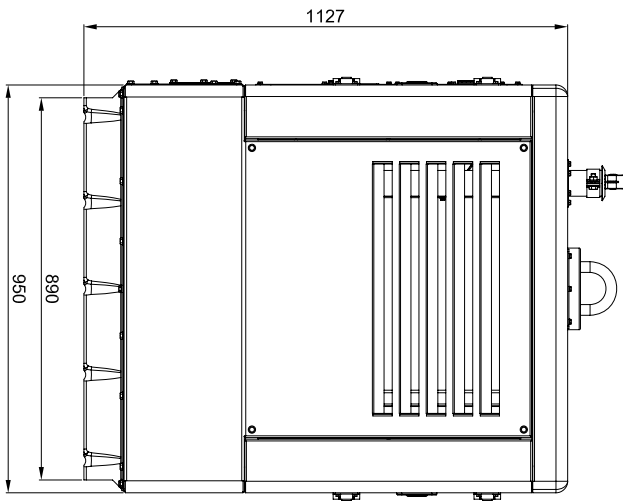

CAPACIDAD DE DEPOSITO = 85 LTS

		PROYECTO:	
Las tolerancias o límites de espesores de origen, a de fabricacion, se aplican a las superficies de trabajo a menos que se indique lo contrario. El material suministrado se entregará en el estado en que se encuentra en el momento de la entrega. El comprador se responsabiliza de verificar las especificaciones de los materiales antes de aceptar el pedido.		G.E. INSONORO 20-30 Kva R12	
MODIFICADO	J.S.BELAR	MODIFICADO	08-May-2012
DIBUJADO	J.S.BELAR	DIBUJADO	08-May-2012
COMPROBADO	A.L.SOLANO	COMPROBADO	08-May-2012
CODIGO		CODIGO	
RENO		RENO	
ESCALA		ESCALA	
DENOMINACION:		DENOMINACION:	
G.E. INSONORO 20-30 Kva R12		G.E. INSONORO 20-30 Kva R12	
DIMENSIONES GENERALES		DIMENSIONES GENERALES	
MATERIAL		MATERIAL	
TOLERANCIA GENERAL		TOLERANCIA GENERAL	
Nº MOD.		Nº MOD.	
MARCA		MARCA	

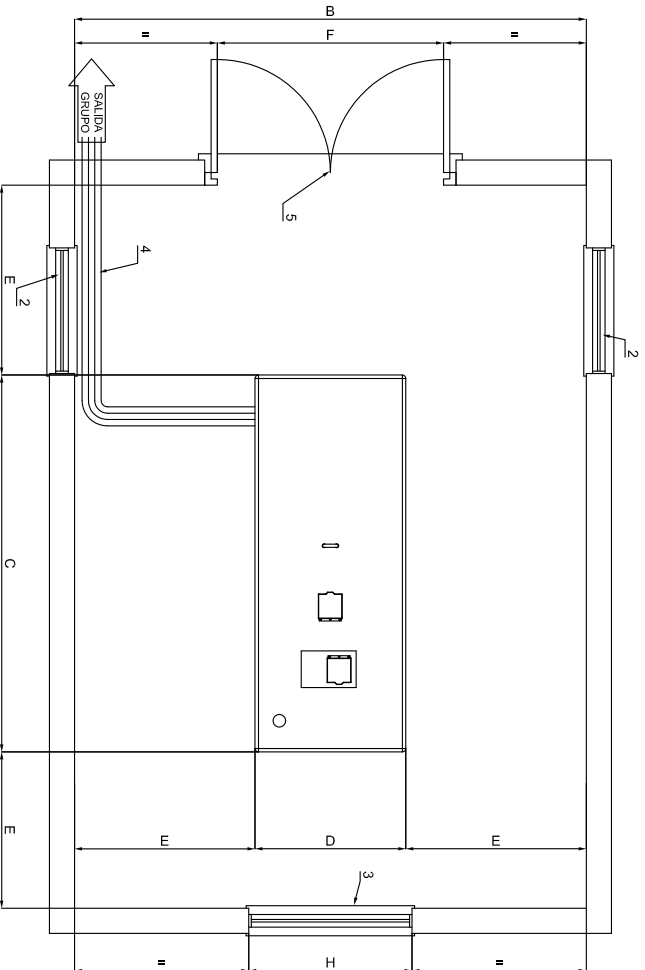
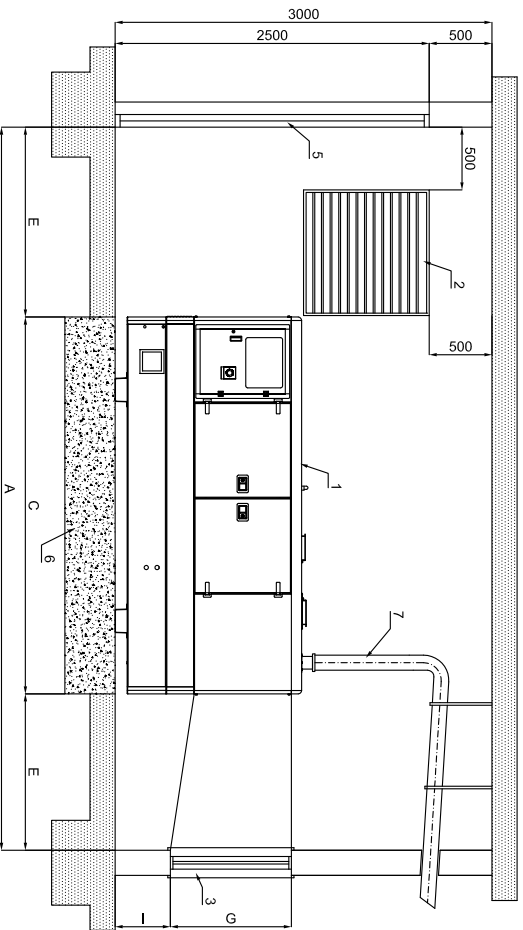

DIMENSIONES MINIMAS DE SALA SEGUN POTENCIA										
POTENCIA (Kva)	A	B	C	D	E	F	G	H	I	SECCION HUECO ENTRADA AIRE
8-15 ABATIBLE	3365	2800	1365	800	1000	900	700	850	450	2x0.50 m ²
10-15	3600	2900	1600	900	1000	1100	700	850	450	2x0.50 m ²
20-30	4000	2950	2000	950	1000	1200	750	850	450	2x0.50 m ²
40-60-75	4500	3100	2500	1100	1000	1400	900	1100	450	2x0.90 m ²
85-105-130	5000	3200	3000	1200	1000	1400	900	1100	450	2x1.00 m ²
150-180-200-250	5600	3350	3600	1350	1000	1550	1150	1300	500	2x2.50 m ²
300-400	6200	3600	4200	1600	1000	1800	1250	1600	650	2x3.00 m ²
450-470-500-510-600-650	6800	4000	4800	2000	1000	2200	1300	1800	725	2x3.50 m ²

- NOMENCLATURA**
- 1.- GRUPO ELECTROGENO
 - 2.- HUECO ENTRADA DEL AIRE
 - 3.- TUNEL EXPULSION DEL AIRE
 - 4.- BANDEJA PASACABLES
 - 5.- PUERTA DE ACCESO
 - 6.- BASE HORMIGON ARMADO H-175
 - 7.- TUBO DE ESCAPE

CALCULO ESPESOR LOSA DE HORMIGON

$$E = \frac{W}{d \times D \times C}$$

E = altura bloque de hormigon
 W = peso total grupo electrogeno
 d = densidad del hormigon (2400 kg/m³)
 D = anchura bloque de hormigon (m)
 C = longitud bloque de hormigon (m)

EL Ø DE LA TUBERIA DE EXTENSION DEL ESCAPE PUEDE SER EL MISMO QUE EL DEL SILENCIADOR HASTA 5 m. PARA DISTANCAS MAYORES DE 5 m. DEBE AUMENTARSE EL Ø DE LA TUBERIA 10 mm POR CADA 10 m MAS DE DISTANCIA ENTRE EL GRUPO ELECTROGENO Y LA SALIDA EXTERIOR

		PROYECTO:		GRUPO INSONORIZADO			
<p>Una autorización o unificar en apariencia, una obra o parte de ella, no constituye un reconocimiento de responsabilidad por parte de NIMESOL. NIMESOL no se responsabiliza por los daños o perjuicios que se ocasionen por el uso de sus productos o por la falta de mantenimiento de los mismos.</p>							
CODIGO	FECHO	ESCALA	MODIFICADO	AGUILAR	02-Ene-2015	MATERIAL	
			DIBUJADO	J.GEBELAR	27-Feb-2008	TOLENCIA GENERAL	
			COMPROBADO	JL SOLANO	04-Oct-2012	UDS.	
			DENOMINACION:	GRUPO INSONORIZADO		EXPEDIENTE:	
				DIMENSIONES DE SALA		Nº PLANO	MARCA