

II-055 - FPT - N 45AM2

1.500 R.P.M. | 50 Hz

TECHNICAL SPECIFICATIONS



Model:

II-055

Gen set with manual control panel.

Image for guidance purposes.

| ENGINE | MAKE | MODEL |
|------------|----------------------|-------------|
| | FPT | NEF N 45AM2 |
| ALTERNATOR | MODEL | |
| | MECC-ALTE ECP32-1L/4 | |

(400 / 230 V)

| | |
|--|---------------|
| CONTINUOUS POWER: (PRP "Prime Power" norma ISO 8528-1) | 50 kVA |
| STAND-BY POWER: (LTP "Limited Time Power" norma ISO 8528-1) | 55 kVA |

Amperes in the different voltages:

| VOLTAGE | HZ | PHASE | COS Ø | PRP KVA/KW | LTP KVA/KW | AMPERAGE |
|---------|----|-------|-------|------------|------------|----------|
| 415/240 | 50 | 3 | 0,8 | 50,0/40,0 | 55,0/44,0 | 76,61 |
| 400/230 | 50 | 3 | 0,8 | 50,0/40,0 | 55,0/44,0 | 79,48 |
| 380/220 | 50 | 3 | 0,8 | 50,0/40,0 | 55,0/44,0 | 83,66 |
| 240/139 | 50 | 3 | 0,8 | 50,0/40,0 | 55,0/44,0 | 132,47 |
| 230/133 | 50 | 3 | 0,8 | 50,0/40,0 | 55,0/44,0 | 138,23 |
| 220/127 | 50 | 3 | 0,8 | 50,0/40,0 | 55,0/44,0 | 144,51 |

ELECTRO EXIM SRL

ELECTRO EXIM SRL
21 Ialomicioarei St., sector 1, code 011277, BUCHAREST - ROMANIA
Phone: 0040 21 2231347 - 0040 744 755 390 - FAX: 0040 21 2231201
E-mail: office@electroexim.com - Web: www.electroexim.ro

II-055 - FPT - N 45AM2

1.500 R.P.M. | 50 Hz

ENGINE CHARACTERISTICS

| MAKE | MODEL |
|------|-------------|
| FPT | NEF N 45AM2 |

GENERAL DATA

| | |
|--------------------------|------------|
| Power PRP (kWm) | 45.00 |
| Power LTP (kWm) | 49.70 |
| No. cylinders | 4 |
| Cylinder capacity (L) | 4.50 |
| Diameter per stroke (mm) | 104 x 132 |
| Compression ratio | 17.50 |
| Cooling system | LIQUID |
| Injection | DIRECT |
| Suction | NATURAL |
| Series regulator | MECHANICAL |
| Fly wheel coupling | - |

Lubrication system

| | |
|-------------------------------|-------|
| Oil capacity (L) | 12.80 |
| Oil consumption (%) | 0.10 |
| Min. alarm oil pressure (bar) | - |

Ventilation system

| | |
|-----------------------------------|---------|
| Air cooling flow (m3/h) | 6480 |
| Combustion air flow (m3/h) | 1000.00 |
| Max. back pressure for fan (mbar) | 20 |

Exhaust system

| | |
|------------------------------|-----|
| Exhaust gas flow (m3/h) | 495 |
| Exhaust back pressure (mbar) | 100 |
| Temp. exhaust gases (°C) | 488 |

Electrical system

| | |
|----------------------|----|
| VDC (V) | 12 |
| Battery (Ah) | 90 |
| Engine start-up (kW) | 3 |

ELECTRO EXIM SRL

ELECTRO EXIM SRL
21 Ialomicioarei St., sector 1, code 011277, BUCHAREST - ROMANIA
Phone: 0040 21 2231347 - 0040 744 755 390 - FAX: 0040 21 2231201
E-mail: office@electroexim.com - Web: www.electroexim.ro

II-055 - FPT - N 45AM2

1.500 R.P.M. | 50 Hz

ALTERNATOR CHARACTERISTICS

MODEL

MECC-ALTE ECP32-1L/4 (400 / 230 V)

GENERAL DATA

| | |
|-----------------------|--------|
| Power PRP (kVA) | 50.00 |
| Power LTP (kVA) | 55.00 |
| Efficiency Alt. 3/4 % | 89.50 |
| Efficiency Alt. 4/4 % | 89.10 |
| No. Poles | 4 |
| Voltage regulator | DSR |
| No. wires | H |
| Insulation | 245.00 |
| Xd (%) | 13.50 |
| X'd (%) | 7.40 |
| X | 21 |
| Degree of protection | IP |

GENERATOR SET CONSUMPTION

| % POWER USED | LITRES/HOUR |
|--------------|-------------|
| 50% | 6.20 |
| 75% | 9.60 |
| 100% | 11.60 |

DIMENSIONS, CAPACITIES, APPROXIMATE WEIGHT AND NOISE

| LENGTH | DIMENSIONS (MM) | |
|----------------------|-----------------|-------------|
| | WIDTH | HEIGHT |
| 2500 | 1100 | 1455 |
| FUEL TANK (LITRES) | | WEIGHT (KG) |
| 85 | | - |
| NOISE LEVEL (dB (A)) | | |

ELECTRO EXIM SRL

ELECTRO EXIM SRL
21 Ialomicioarei St., sector 1, code 011277, BUCHAREST - ROMANIA
Phone: 0040 21 2231347 - 0040 744 755 390 - FAX: 0040 21 2231201
E-mail: office@electroexim.com - Web: www.electroexim.ro

II-055 - FPT - N 45AM2

1.500 R.P.M. | 50 Hz

INMESOL GENERATOR SET

GENERAL DESCRIPTION

The "INMESOL" generator set is an electrical energy generating machine which is used in places where there **is no mains supply** or when there is a MAINS failure.

The mobile elements, distribution belt, fan, etc., and those parts which reach high temperatures during operation, exhaust manifold, etc, include their corresponding protections, in compliance with the requirements of the Machinery Directive **2006/42**.

REGULATIONS

The machine holds the "CE" marking, and the corresponding Declaration of Conformity is issued with each of them, in which it specifies that the machine complies with **R.D 842/2002 Low Voltage Regulations and with the European Directives:**

- 2006/42 on Safety in Machinery.
- 2006/95/CE on Electrical Safety.
- 2004/108/CE on Electromagnetic Compatibility.
- 2005/88/CE on NOISE EMISSIONS by equipment for outdoor use (for SOUNDPROOF GENERATOR SETS).

II-055 - FPT - N 45AM2

1.500 R.P.M. | 50 Hz

IN INDUSTRIAL RANGE / SCOPE OF SUPPLY

| |  |  |
|---|---|---|
| Engine/alternator monobloc directly connected and installed via silent blocks on a frame made from high tensile electro welded steel profiles that are treated with degreasing liquids and aplicated with a phosphate coat and epoxi paint. | <input checked="" type="checkbox"/> | <input checked="" type="checkbox"/> |
| Canopy of steel sheet sound proofed with fireproof rockwool, and treated with degreasing liquids and aplicated with a phosphate coat and epoxi paint. | <input type="checkbox"/> | <input checked="" type="checkbox"/> |
| Fuel tank integrated in the base frame provided with fuel level jauge and fuel connections to the engine. | <input checked="" type="checkbox"/> | <input checked="" type="checkbox"/> |
| Engine with mechanical engine driven pusher fan. | <input checked="" type="checkbox"/> | <input checked="" type="checkbox"/> |
| Industrial silencer with -15 db(A) noise reduction and exhaust outlet tube. | <input checked="" type="checkbox"/> | <input type="checkbox"/> |
| Residencial silencer with -35 db(A) noise reduction with exhaust tube and protection cap. | <input type="checkbox"/> | <input checked="" type="checkbox"/> |
| Electric control cubicle with control module including protection and reading of electrical meassures engine instrumentation fuel level and engine running hours, etc. | <input checked="" type="checkbox"/> | <input checked="" type="checkbox"/> |
| Termal and magnetic circuit breaker and termal and magnetic circuit breaker and earth fault relay. | <input checked="" type="checkbox"/> | <input checked="" type="checkbox"/> |
| Battery charge alternator. | <input checked="" type="checkbox"/> | <input checked="" type="checkbox"/> |
| Starter battery complete with cables to the engine and pole protection. | <input checked="" type="checkbox"/> | <input checked="" type="checkbox"/> |
| Installation prepared for earthing spike (spike not included). | <input checked="" type="checkbox"/> | <input checked="" type="checkbox"/> |
| Security protection for heat and moving parts as well as live electrical components. | <input checked="" type="checkbox"/> | <input checked="" type="checkbox"/> |
| External emergency stop push button. | <input checked="" type="checkbox"/> | <input checked="" type="checkbox"/> |
| Manual engine oil extraction pump. | <input type="checkbox"/> | <input checked="" type="checkbox"/> |
| Self excited and auto regulated alternator. | <input checked="" type="checkbox"/> | <input checked="" type="checkbox"/> |
| Integrated lifting hook for single point lifting with crane, gensets up to 450 kVA (Except in swing-out cover model) | <input type="checkbox"/> | <input checked="" type="checkbox"/> |
| 4 Lifting points for gen sets from 450 kVA and bigger. | <input checked="" type="checkbox"/> | <input type="checkbox"/> |
| Preparate for extended fuel tank, fully bomded for leakage protection. | <input checked="" type="checkbox"/> | <input checked="" type="checkbox"/> |
| Base frame is prepared for trailer kit installation. | <input checked="" type="checkbox"/> | <input checked="" type="checkbox"/> |
| Standard electronic speed governor on engines from 220 kVA (LTP) and up. | <input checked="" type="checkbox"/> | <input checked="" type="checkbox"/> |
| Horizontal outlet for hot air | <input type="checkbox"/> | <input checked="" type="checkbox"/> |

DSE 3110 MANUAL CONTROL PANEL

DSE 3110 MANUAL CONTROL PANEL

MANUAL CONTROL, PROTECTION AND DISTRIBUTION panel, assembled on the generator set in metal cabinet with a DSE 3110 engine protection unit.



It has the following:

Image for guidance purposes.

1 STARTER SWITCH

2 EMERGENCY STOP PUSHBUTTON

3 MEASURING INSTRUMENTS:

- 3 Analogue Ammeters.
- 1 Analogue Voltmeter with a separated phases selector.
- Fuel Level Indicator
- Digital Reading of Hz and Functioning Hours Counting (DSE 3110)

II-055 - FPT - N 45AM2

1.500 R.P.M. | 50 Hz

DSE 3110 MANUAL CONTROL PANEL

4 SET CONTROL AND ENGINE PROTECTION: DSE 3110, allows:

- START AND STOP the set MANUALLY.
- Possibility of doing it AUTOMATICALLY via START ON SIGNAL
- Digital readings of the operating hours and the Frequency
- Controls the main characteristics of the engine, causing an alarm or stopping the machine:
 - 1.Low and High Voltage (STOP)
 - 2.Low and High Frequency and Speed (STOP)
 - 3.Low Oil Pressure and High Coolant Temperature (STOP)
 - 4.Failure of the Alternator Battery-Charger (ALARM)
 - 5.Low fuel level (ALARM)

5 PROTECTIONS:

- Magnetothermal Protections
- Earth Leak Protection
- Protection fuses for control module

II-055 - FPT - N 45AM2

1.500 R.P.M. | 50 Hz

DSE 3110 MANUAL CONTROL PANEL

For **OPEN sets** - Three-phase generators (single phase by request):

| CONT . POW. | MAGNETO. PROTECTION (A) | EARTH LEAK PROTECTION | DISTRIBUTION |
|------------------|-------------------------|-----------------------|-----------------------|
| 10 kVA | 4P, 16A (B) | Mod. 16A, 300 mA | 1 B. CEE 3P+N+T 16A |
| 13 kVA | 4P, 20A (B) | Mod. 25 A, 300 mA | 1 B. CEE 3P+N+T 32A |
| 15 kVA | 4P, 25A (B) | Mod. 25 A, 300 mA | 1 B. CEE 3P+N+T 32A |
| 20 kVA | 4P, 32 A (B) | Mod. 32 A, 300 mA | 1 B. CEE 3P+N+T 32 A |
| | 1P+N 16 A (C) | | 1 B. CEE 2P+T 16 A |
| 30 kVA | 4P, 50 A (B) | Mod. 63 A, 300 mA | 1 B. CEE 3P+N+T 63 A |
| | 3P 16 A (C) | | 1 B. CEE 3P+N+T 16 A |
| 40 kVA | 1P+N 16 A (C) | Mod. 63 A, 300 mA | 1 B. CEE 2P+T 16 A |
| | 4P, 63 A (B) | | 1 B. CEE 3P+N+T 63 A |
| 50 kVA | 3P 16 A (C) | Electronic adjustable | 1 B. CEE 3P+N+T 16 A |
| | 1P+N 16 A (C) | | 1 B. CEE 2P+T 16 A |
| 60 kVA | 4P, 100 A (B) | Electronic adjustable | 1 B. CEE 3P+N+T 125 A |
| | 3P 16 A (C) | | 1 B. CEE 3P+N+T 16 A |
| 75-80 kVA | 1P+N 16 A (C) | Electronic adjustable | 1 B. CEE 2P+T 16 A |
| | 4P, 125 A (B) | | 1 B.CEE 3P+N+T 16 A |
| 100 kVA | 3P 16 A (C) | Electronic adjustable | 1 B.SCHUKO 2P+T 16 A |
| | 1P+N 16 A (C) | | 1 POWER TERMINALS |
| 125-150 kVA | 3P, 160 A (B) | Electronic adjustable | 1 B. CEE 3P+N+T 16A |
| | 3P 16 A (C) | | 1 B. SCHUKO 2P+T 16 A |
| 200-275 kVA | 1P+N 16 A (C) | Electronic adjustable | 1 B. CEE 3P+N+T 16A |
| | 3P, 400 A (B) | | 1 B. SCHUKO 2P+T 16 A |
| 300-400 kVA | 3P 16 A (C) | Electronic adjustable | 1 B. CEE 3P+N+T 16A |
| | 1P+N 16 A (C) | | 1 B. SCHUKO 2P+T 16 A |
| 450 kVA VOLVO | 3P, 800 A (B) | Electronic adjustable | 1 B. CEE 3P+N+T 16A |
| | 3P 16 A (C) | | 1 B. SCHUKO 2P+T 16 A |
| 430 kVA DEUTZ | 1P+N 16 A (C) | Electronic adjustable | 1 POWER TERMINALS |
| | 3P, 800 A (B) | | 1 POWER TERMINALS |
| 450-500 kVA | 3P, 630 A (B) | Electronic adjustable | 1 POWER TERMINALS |
| 570-650 kVA | 3P, 1000 A (B) | Electronic adjustable | 1 POWER TERMINALS |

II-055 - FPT - N 45AM2

1.500 R.P.M. | 50 Hz

DSE 3110 MANUAL CONTROL PANEL

6 OPTIONAL:

AUTOMATIC PANEL FOR MANUAL GENERATOR: ATS DSE 334

- This panel provides the manual control generator with a reserve operation from the Mains, as the ATS sends the command to start and stop the generator, when it detects a supply failure and when the Mains is restored



Cubicle composed of the electronic control module which is detecting a mains failure and of 2 contactors mechanically and electrically interlocked or a motorized switch controlled by the above electronic controller who are realizing the change of supply from the GEN SET or the MAINS to the load.

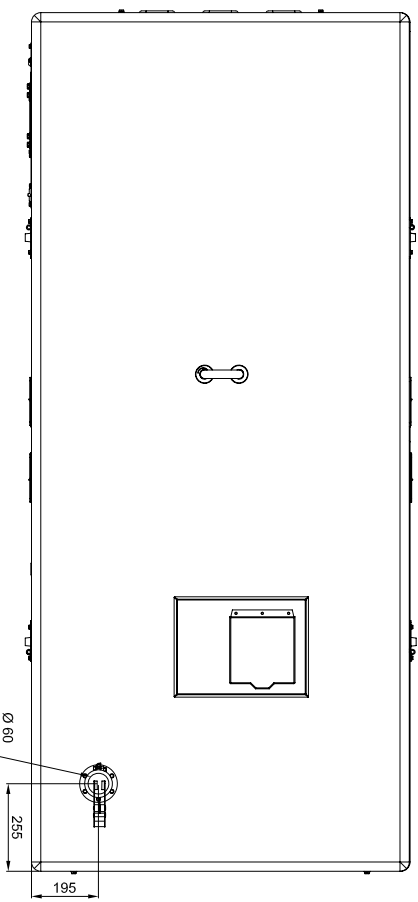
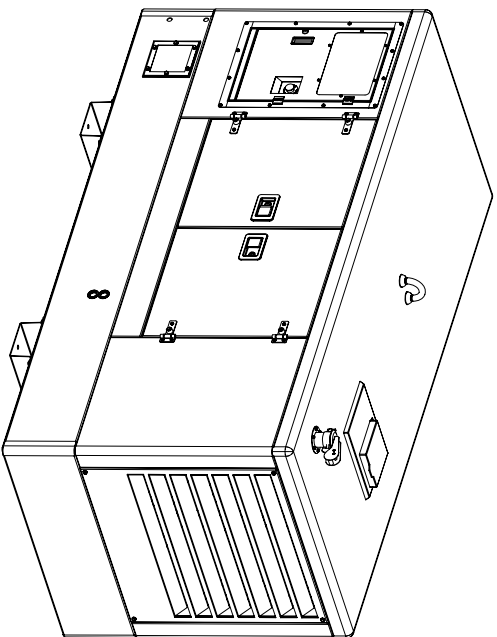
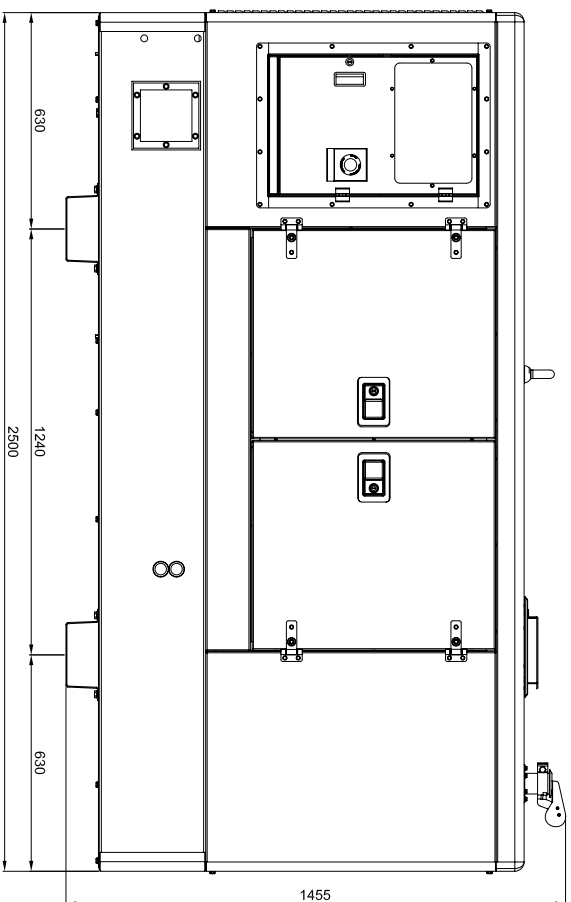
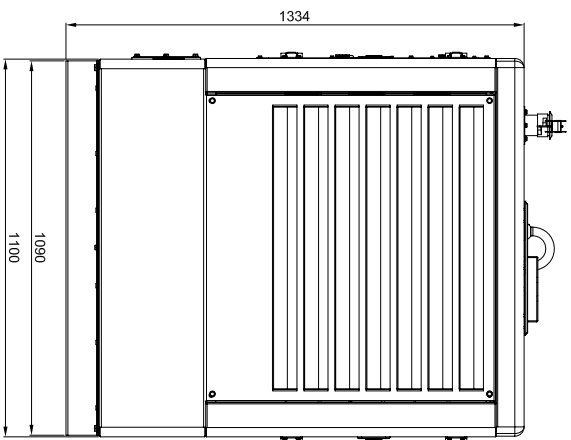

CAPACIDAD DE DEPOSITO = 85 LTS

| | | | | | |
|---|--|--|--|------------------------------------|--|
|  | | <p>Una licencia a cumplir en apariencia de obra, a la vez que un trabajo de ingeniería, que exige el cumplimiento de todas las normas técnicas y de seguridad que rigen la actividad profesional, así como el cumplimiento de las obligaciones de índole técnica y de seguridad que impone la ley.</p> | | <p>PROYECTO:</p> | |
| <p>COMPRESOR</p> | | <p>INMIESOL</p> | | <p>G.E. INSONORO 40-60 KVA R12</p> | |
| <p>MODELO</p> | | <p>J.G.BEABR</p> | | <p>MATERIAL</p> | |
| <p>DIBUJADO</p> | | <p>J.G.BEABR</p> | | <p>TOLEFANICA GENERAL</p> | |
| <p>COMPROBADO</p> | | <p>J.L.SOLANO</p> | | <p>U.S.</p> | |
| <p>CONIGO</p> | | <p>23/04/2012</p> | | <p>mm</p> | |
| <p>PESO</p> | | <p>23/04/2012</p> | | <p>Nº MOD</p> | |
| <p>ESCALA</p> | | <p>G.E. INSONORO 40-60 KVA R12</p> | | <p>EXEQUENTE:</p> | |
| | | <p>DIMENSIONES GENERALES</p> | | <p>Nº PLANO</p> | |
| | | | | <p>MARCA</p> | |

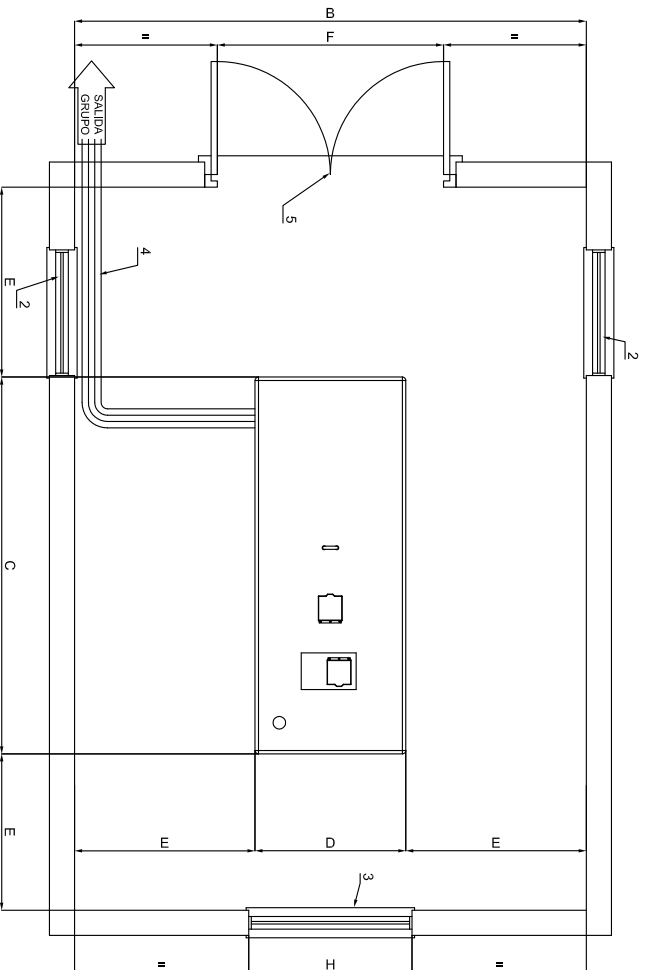
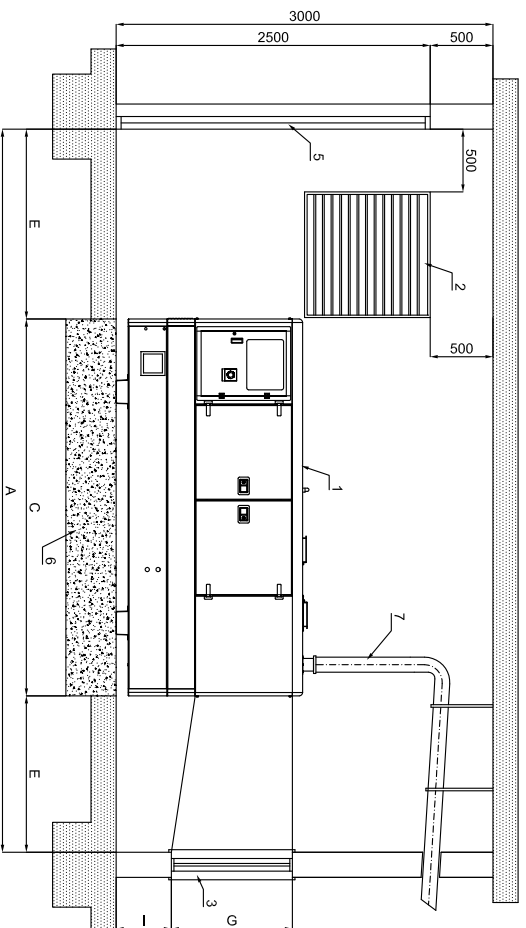

| DIMENSIONES MINIMAS DE SALA SEGUN POTENCIA | | | | | | | | | | |
|--|------|------|------|------|------|------|------|------|-----|----------------------------|
| POTENCIA (Kva) | A | B | C | D | E | F | G | H | I | PESO |
| 8-15 ABATIBLE | 3365 | 2800 | 1365 | 800 | 1000 | 900 | 700 | 850 | 450 | SECCION HUECO ENTRADA AIRE |
| 10-15 | 3600 | 2900 | 1600 | 900 | 1000 | 1100 | 700 | 850 | 450 | 2x0,50 m ² |
| 20-30 | 4000 | 2950 | 2000 | 950 | 1000 | 1200 | 750 | 850 | 450 | 2x0,50 m ² |
| 40-60-75 | 4500 | 3100 | 2500 | 1100 | 1000 | 1400 | 900 | 1100 | 450 | 2x0,90 m ² |
| 85-105-130 | 5000 | 3200 | 3000 | 1200 | 1000 | 1400 | 900 | 1100 | 450 | 2x1,00 m ² |
| 150-180-200-250 | 5600 | 3350 | 3600 | 1350 | 1000 | 1550 | 1150 | 1300 | 500 | 2x2,50 m ² |
| 300-400 | 6200 | 3600 | 4200 | 1600 | 1000 | 1800 | 1250 | 1600 | 650 | 2x3,00 m ² |
| 450-470-500-510-630-650 | 6800 | 4000 | 4800 | 2000 | 1000 | 2200 | 1300 | 1800 | 725 | 2x3,50 m ² |

- NOMENCLATURA**
- 1.- GRUPO ELECTROGENO
 - 2.- HUECO ENTRADA DEL AIRE
 - 3.- TUNEL EXPULSION DEL AIRE
 - 4.- BANDEJA PASACABLES
 - 5.- PUERTA DE ACCESO
 - 6.- BASE HORMIGON ARMADO H-175
 - 7.- TUBO DE ESCAPE

CALCULO ESPESOR LOSA DE HORMIGON

$$E = \frac{W}{d \times D \times C}$$

E = altura bloque de hormigon
 W = peso total grupo electrogeno
 d = densidad del hormigon (2400 kg/m³)
 D = anchura bloque de hormigon (m)
 C = longitud bloque de hormigon (m)

EL Ø DE LA TUBERIA DE EXTENSION DEL ESCAPE PUEDE SER EL MISMO QUE EL DEL SILENCIADOR HASTA 5 m. PARA DISTANCAS MAYORES DE 5 m. DEBE AUMENTARSE EL Ø DE LA TUBERIA 10 mm POR CADA 10 m MAS DE DISTANCIA ENTRE EL GRUPO ELECTROGENO Y LA SALIDA EXTERIOR

| | | | |
|---|---------------|--|--------------------|
| | | GRUPO INSONORIZADO | |
| PROYECTO: | | | |
| Una declaración de cumplir con la presente es obligatoria para todos los proyectos de obra que se realicen con el producto NIMESOL, tanto en el momento de la licitación como al momento de la adjudicación y ejecución de la obra. | MODIFICADO | A.GUILAR | 02-Ene-2015 |
| CODIGO | DIBUJADO | J.GIBELAR | 27-Feb-2008 |
| PESO | COMPROBADO | J.L.SOLANO | 04-Oct-2012 |
| ESCALA | DENOMINACION: | GRUPO INSONORIZADO DIMENSIONES DE SALA | MATERIAL |
| | | | TOLERANCIA GENERAL |
| | | | UDS. |
| | | | EXPEDIENTE: |
| | | | Nº MOD. |
| | | | Nº PLANO |
| | | | MARCA |